

6 5 4 3 2 1

D
C
B
A

D
C
B
A

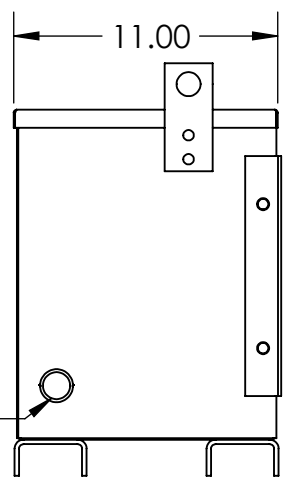
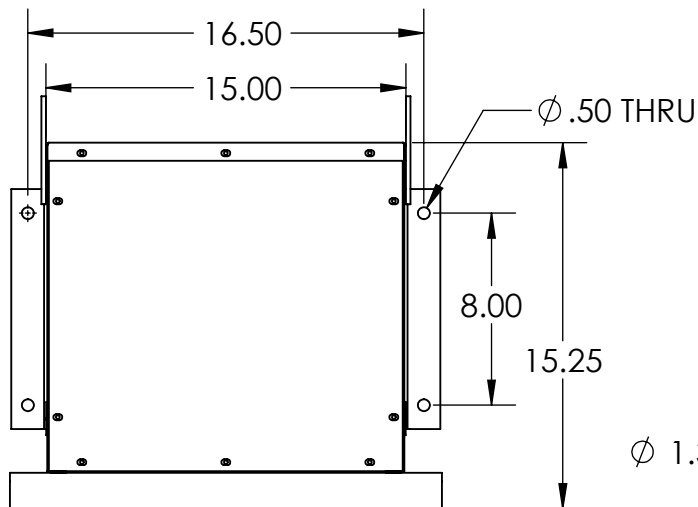
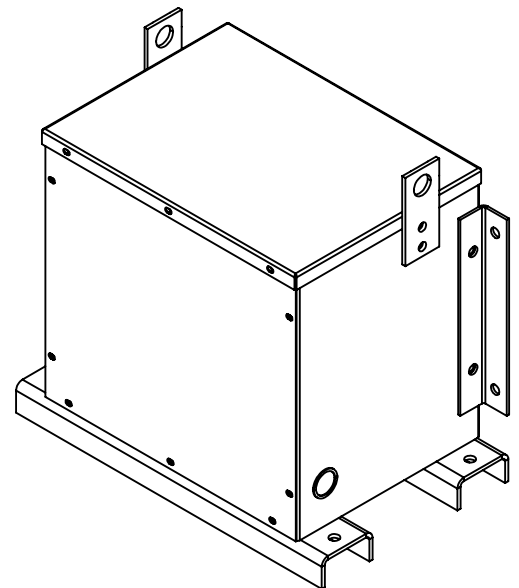
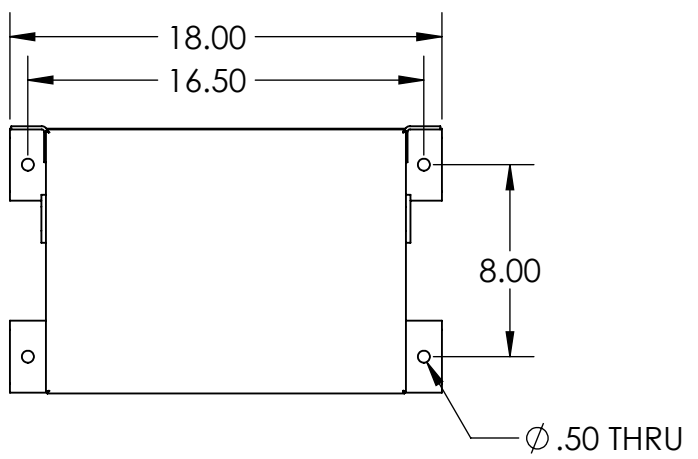

- CSA Enclosure:
 1. Type 3R (NEMA 3R)
 2. ASA 61 grey
 3. Floor/Wall mounting
 4. Weight : 33 Lbs

UNLESS OTHERWISE SPECIFIED:
 DIMENSIONS ARE IN INCHES
 .XX = ± 0.05"
 .XXX = ± 0.030"
 .XXXX = ± 0.005"
 FRACTIONS = ± 1/16"
 ANGLES = ± 1°

THE INFORMATION ON THIS DRAWING IS THE PROPERTY OF REX POWER MAGNETICS. IS DISCLOSED IN CONFIDENCE AND IS NOT TO BE REPRODUCED, USED OR DISCLOSED EXCEPT FOR THE PURPOSE FOR WHICH FURNISHES.

THIRD-ANGLE PROJECTION

	NAME	DATE
DRAWN	WW	01/11/2021
APPROVED	VS	01/11/2021
MATERIAL	STEEL	
FINISH	ASA 61 GREY	
REX POWER MAGNETICS		

TITLE: ENCAPSULATED ENCLOSURE		
SIZE A	DWG. NO. E3R-3PEP-2	REV 1
SCALE: 1:1	WEIGHT: 33.42 LBS	SHEET 1 OF 1

6 5 4 3 2 1