

4

3

2

1

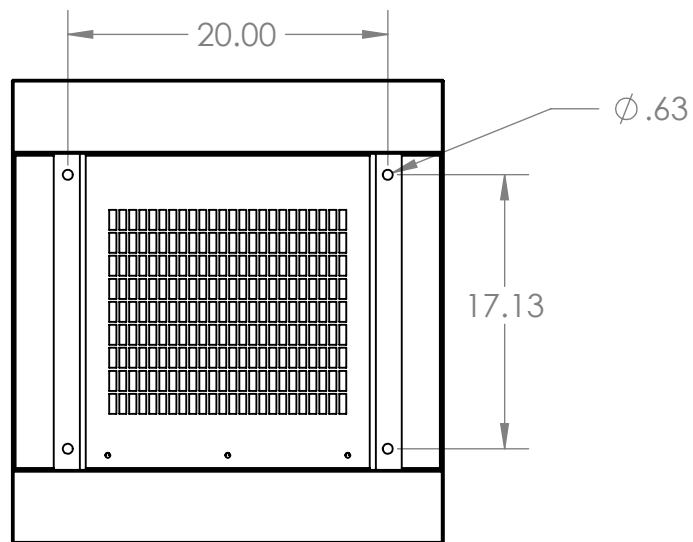
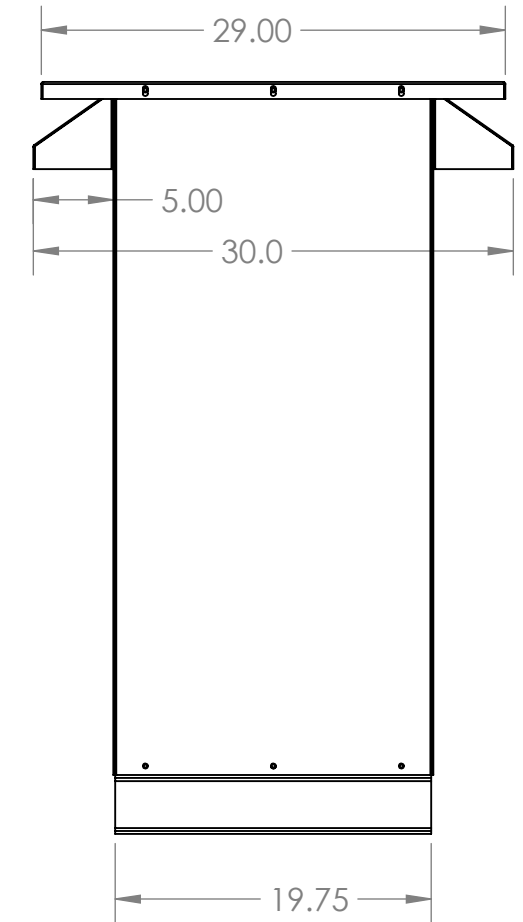
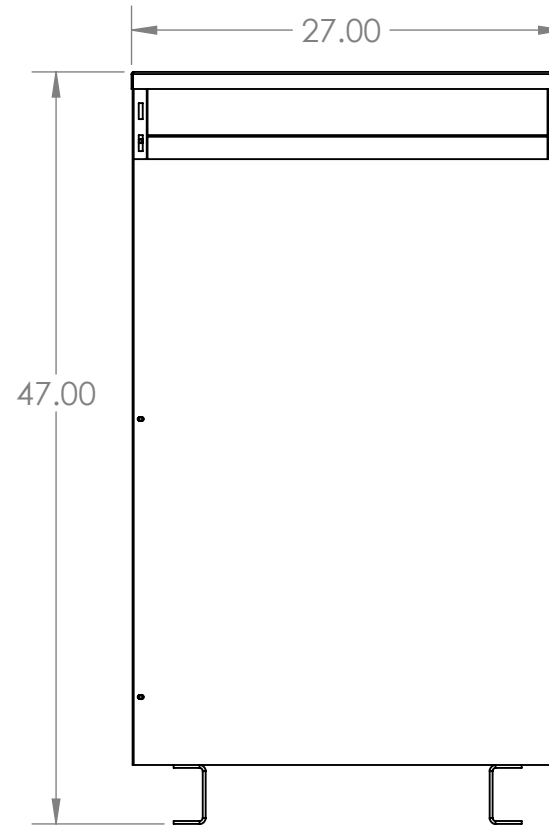
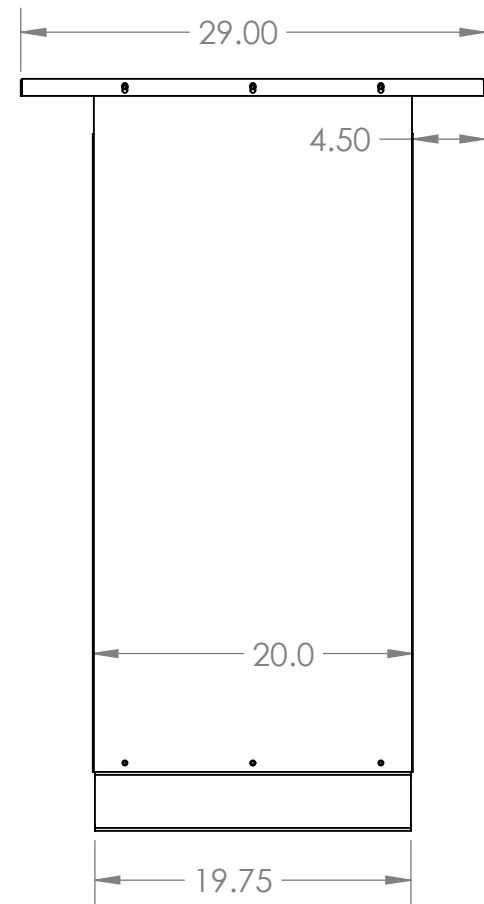
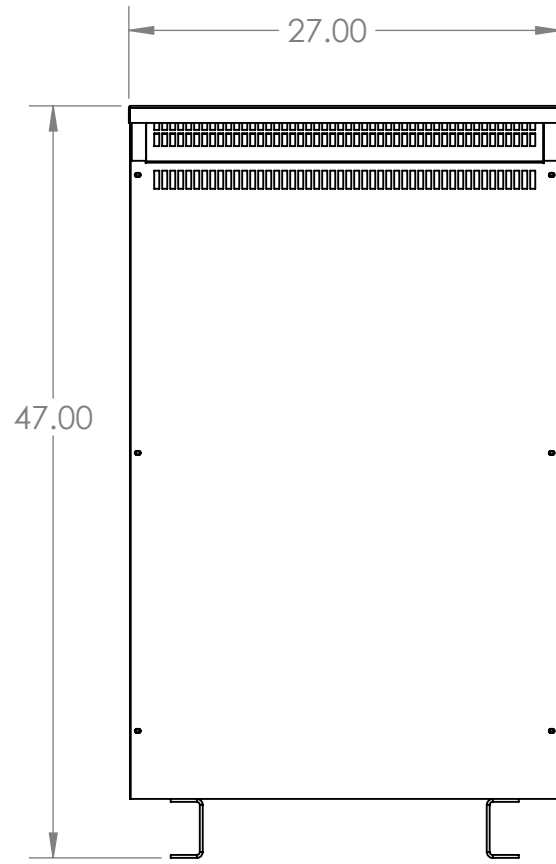

- CSA Enclosure: E3R-8S-W
- 1.Type 3R (NEMA 3R)
- 2. Indoor/Outdoor ventilated
- 3. ASA 61 Grey
- 4. Floor mounting
- 5. Weight: 115 lbs

- CSA Enclosure: E3R-8S
- 1.Type 3R (NEMA 3R)
- Sprinklerproof when the angle between sprinkler heads and opening in the enclosure does not exceed 45 degree from the vertical
- 2. Indoor ventilated
- 3. ASA 61 Grey
- 4. Floor mounting
- 5. Weight: 107 lbs

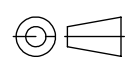
UNLESS OTHERWISE SPECIFIED:		NAME	DATE	TITLE:	
DIMENSIONS ARE IN INCHES		DRAWN	JB	ENCLOSURE - NEMA 3R	
.XX = ± 0.05"		ENG APPR.	VS	#8S	
.XXX = ± 0.030"		MFG APPR.		SIZE	DWG. NO.
.XXXX = ± 0.005"		MATERIAL	STEEL	B	E3R-8S/E3R-8S-W
FRACTIONS = ± 1/16"		FINISH	ASA 61 GREY	SCALE: 1:12	WEIGHT:
ANGLES = ±1°				REV	1
<small>THE INFORMATION ON THIS DRAWING IS THE PROPERTY OF REX POWER MAGNETICS. IT IS DISCLOSED IN CONFIDENCE AND IS NOT TO BE REPRODUCED, USED OR DISCLOSED EXCEPT FOR THE PURPOSE FOR WHICH FURNISHED.</small>				SHEET 1 OF 1	

4

3

2

1